



# POLY SF



Masonry



Option 7



## BCR-400 POLY SF

Cartuccia coassiale  
Coaxial cartridge  
Cartouche coaxial  
Koaxialkartusche  
400 ml  
cod. 747176



## BCR-300 POLY SF

Cartuccia sacchetto  
Foil cartridge  
Cartouche avec sachet  
Schlauchfolienkartusche  
300 ml  
cod. 747138



## BCR-300 ! /400 ! POLY SF

300 ml  
cod. 747144



400 ml  
cod. 747169



## BCR-165 POLY SF

Cartuccia sacchetto  
Foil cartridge  
Cartouche avec sachet  
Schlauchfolienkartusche  
165 ml  
cod. 747122



**STOCCAGGIO E CONSERVAZIONE**  
STORAGE AND CONSERVATION  
STOCKAGE ET CONSERVATION  
LAGERUNG UND AUFBEWAHRUNG



**CARTUCCIA**  
CARTRIDGE  
CARTOUCHE  
KARTUSCHE



**DURATA (mesi)**  
EXPIRY (months)  
ECHEANCE (mois)  
HALTBARKEIT (Monate)

## POLY-SF ! TON PIERRE

PRODOTTO SU RICHIESTA, ORDINI  
PROGRAMMATI LEGATI A QUANTITÀ  
MINIME

ON DEMAND PRODUCT; ORDER PLANNING  
REQUIRED IN CONNECTION WITH SPECIFIC  
QUANTITIES.

PRODUIT SUR REQUÊTE; PLANIFICATION  
DES COMMANDE NÉCESSAIRE DANS LE  
CADRE DE QUANTITÉS SPÉCIFIQUES

ON DEMAND-PRODUKT;  
AUFTRAGSPLANUNG ERFORDERLICH IN  
VERBINDUNG MIT SPEZIFISCHEN MENGEN.

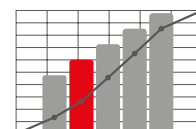



**SCHEDA TECNICA  
TECHNICAL DATA SHEET  
FICHE TECHNIQUE  
TECHNISCHES DATENBLATT**

**POLYSF**

**RESINA POLIESTERE SENZA STIRENE | POLYESTER RESIN STYRENE FREE  
RÉSINE POLYESTER SANS STYRÈNE | POLYESTERHARZ STYROLFREI**

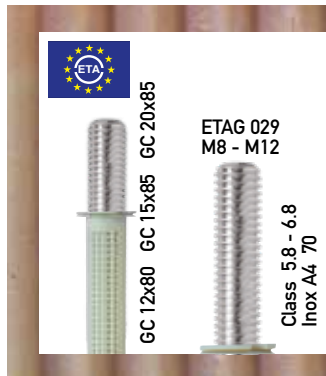
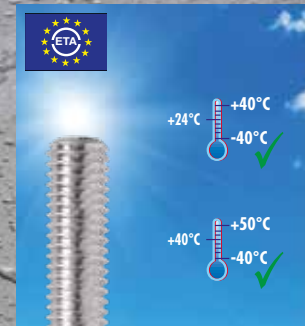
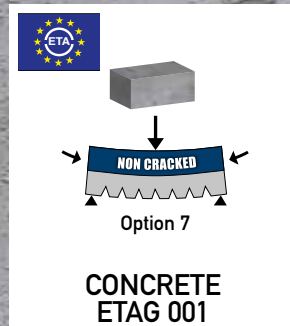
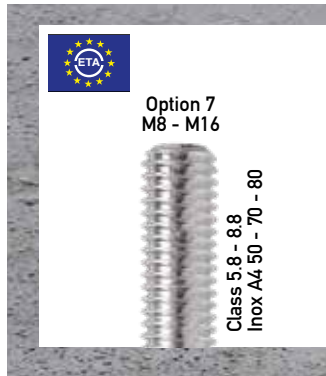

**IT. ANCORANTE CHIMICO BI-COMPONENTE POLIESTERE SENZA STIRENE PER CARICHI MEDI, MARCATO CE E QUALIFICATO ETA PER FISSAGGI IN CALCESTRUZZO, MURATURA PIENA E LATERIZI FORATI.**

ETA (European Technical Assessment) aggiornati in accordo al Regolamento Prodotti da Costruzione 305/2011.

ETA-15/0560: Qualifica per calcestruzzo non fessurato, Opzione 7, in accordo a ETAG-001 parte 5, diametri da M8 a M16. Il prodotto è omologato per fissaggi con profondità variabile di ancoraggio, per dare a progettisti ed utilizzatori un'elevata flessibilità. Massima profondità di ancoraggio fino a venti volte il diametro nominale della barra filettata. Carichi per installazione in calcestruzzo asciutto e umido. Le temperature di esercizio certificate sono negli intervalli: -40°C/+50°C (T<sup>0</sup> max lungo periodo = 40°C).

ETA-11/0396: Qualifica per muratura secondo ETAG 029 per ancoraggi in muratura piena, semipiena e forata. Utilizzo anche su murature con umidità temporanea presente solo durante la fase di installazione del prodotto. L'omologazione è valida per un'ampia gamma di murature (6 tipologie di blocchi), barre filettate (da M8 a M12) e di gabbiette (GC 12x80 - GC 15x85 - GC 20x85). Le temperature di esercizio certificate sono negli intervalli -40°C/+40°C (T<sup>0</sup> max lungo periodo = +24°C) e -40°C/+50°C (T<sup>0</sup> max lungo periodo = +40°C).

Temperature del supporto (calcestruzzo, muratura ecc...) per l'installazione comprese tra 0°C e +30°C.

Qualifica VOC in accordo al Decreto francese 2011-321 ed in conformità alla norme ISO 16000/EN 16516.

**EN. BI-COMPONENT POLYESTER STYRENE FREE CHEMICAL ANCHOR FOR MEDIUM LOADS, CE MARKED AND ETA ASSESSED FOR USE IN DIFFERENT BASE MATERIALS AS CONCRETE, SOLID MASONRY AND HOLLOW BRICKS MASONRY.**

ETA (European Technical Assessments) updated according to the Construction Product Regulation 305/2011.

ETA-15/0560: Assessment for uncracked concrete, Option 7, according to ETAG-001 for diameters from M8 to M16. The product is certified for fixing with variable anchorage depths. This means that the project engineer and the user have a high flexibility. Maximum embedment depth up to 20 times nominal threaded rod diameter. Loads for installation in dry and wet concrete. Certified service temperatures are in the ranges: -40°C/+50°C (T<sup>0</sup> max long period = 40°C).

ETA-11/0396: Assessment for masonry according to ETAG 029 for fixings in solid bricks, perforated bricks and hollow bricks. Utilization possible even on masonry with temporary humidity present only during the product installation phase. The product is homologated for being used with a wide range of masonry (6 type of bricks), threaded rods (from M8 to M12) and sleeves (GC 12x80 - GC 15x85 - GC 20x85). Certified service temperatures are in the ranges -40°C/+40°C (T<sup>0</sup> max long period = +24°C) and -40°C/+50°C (T<sup>0</sup> max long period = +40°C).

Base material temperature (concrete, bricks, etc...) for installation between 0° and +30°C.

VOC according to the French Decree 2011-321 and according to the standard ISO 16000/EN 16516.



**GREEN LIFE**

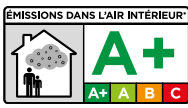

Ministry of Construction of Russia  
**МИНСТРОЙ  
РОССИИ**



FCC  
Federal Center for standardization  
and technical assessment  
of conformity in construction

Eurasian Economic Community

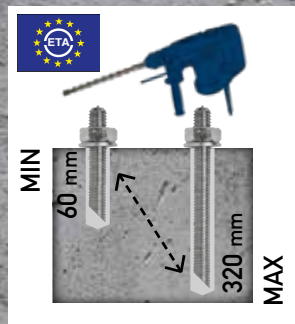

**STONE COLOUR  
PAINTABLE**

CARTUCCIA > CARTRIDGE  
CARTOUCHE > KARTUSCH  
**300 - 165 ml:**  
Sistema di apertura sacchetto  
Plastic foil opening system  
Système d'ouverture à sachet  
Plastik Folien Öffnungssystem

**FR. ANCRAGE CHIMIQUE BI COMPOSANT POLYESTER SANS STYRÈNE POUR CHARGES MOYENNES, MARQUAGE CE ET ÉVALUATION ETA POUR ANCRAGE DANS DIFFÉRENTS MATÉRIEAUX DE CONSTRUCTION COMME LE BÉTON, LA MAÇONNERIE PLEINE ET LES BRIQUES CREUSES.**

ETA (Évaluation Technique Européenne) mise à jour conformément au Règlement sur les Produits de Construction 305/2011.

ETA-15/0560 : Évaluation pour béton non fissuré, Option 7, conformément au Guide d'Agrément Technique Européen ETAG-001 pour diamètres de M8 à M16. Le produit est certifié pour un scellement avec des profondeurs d'ancrage variables. Cela signifie que l'ingénieur de projet et l'utilisateur bénéficient d'une grande flexibilité. Profondeur maximale d'ancrage jusqu'à 20 fois le diamètre nominal de la tige filetée. Charges pour installation dans du béton sec et fluide. Les températures de service certifiées se situent dans l'intervalle suivant : -40°C/+50°C (T° max longue période = 40°C).

ETA-11/0396 : Évaluation pour la maçonnerie conformément au Guide d'Agrément Technique Européen ETAG 029 pour les fixations dans les briques pleines, les briques perforées et les briques creuses. Utilisation possible y compris sur de la maçonnerie avec présence d'humidité temporaire uniquement pendant la phase d'installation du produit. Le produit est homologué pour être utilisé avec une large gamme de maçonnerie (6 types de briques), de tiges filetées (de M8 à M12) et de tamis (GC 12x80 - GC 15x85 - GC 20x85). Les températures de service certifiées se situent entre -40°C/+ 40°C (T° max longue période = +24°C) et -40°C/+50°C (T° longue période = +40°C)

Température du matériau de construction (béton, briques, etc.) pour une installation entre 0° et + 30°C.

COV selon le décret français 2011-321 et selon la norme ISO 16000/ EN16516.

**DE. ZWEIKOMPONENTEN-POLYESTER, STYROLFREI, CHEMISCHER ANKER FÜR MITTELSCHWERE LASTEN, MIT CE-KENNZEICHNUNG UND ETA-BEWERTUNG, ZUR VERWENDUNG IN VERSCHIEDENEN GRUNDWERKSTOFFEN WIE BETON, VOLLMAUERWERK UND HOHLMAUERWERK.**

ETA (European Technical Assessments) gemäß der Bauprodukteverordnung 305/2011 aktualisiert.

ETA-15/0560: Bewertung für ungerissenen Beton, Option 7, gemäß ETAG-001 für Durchmesser von M8 bis M16. Das Produkt ist für die Befestigung mit variabler Verankerungstiefe zertifiziert. Dies bedeutet, dass dem Projektgenieur und dem Benutzer eine hohe Flexibilität zur Verfügung steht. Maximale Einbindetiefe bis zum 20-fachen des Gewindestangendurchmessers. Lasten für den Einbau in trockenem und nassem Beton. Die zertifizierten Betriebstemperaturen liegen in den Bereichen: -40°C/+50°C (Langzeit-T°-max. = 40°C).

ETA-11/0396: Beurteilung für Mauerwerk nach ETAG 029 für Befestigungen in Vollziegeln, Lochziegeln und Hohlziegeln. Der Einsatz ist auch bei Mauerwerk mit temporärer Feuchtigkeit nur während der Produktinstallationsphase möglich. Das Produkt ist homologiert für den Einsatz mit einer breiten Palette von Mauerwerk (6 Ziegelarten), Gewindestangen (von M8 bis M12) und Muffen (GC 12x80 - GC 15x85 - GC 20x85). Die zertifizierten Betriebstemperaturen liegen im Bereich von -40°C/+40°C (Langzeit-T°max = +24°C) und -40°C/+50°C (Langzeit-T°max = +40°C).











Grundwerkstofftemperatur (Beton, Ziegelsteine usw.) für den Einbau zwischen 0° und + 30°C.

VOC gemäß dem französischen Erlass 2011-321 und gemäß der Norm ISO 16000 / EN16516.



# SCHEDA TECNICA TECHNICAL DATA SHEET FICHE TECHNIQUE TECHNISCHES DATENBLATT

## Gamma prodotti | Product's range | Gamme produits | Warenangebot

	CODICE > CODE NUMBER	ARTICOLO > ITEM TYPE > ARTIKEL	DESCRIZIONE > DESCRIPTION DESCRIPTION > BESCHREIBUNG	 Nr.
		<b>POLY SF</b>		
	<b>747176</b>	<b>BCR 400 POLY SF</b>	Cartuccia da > Cartridge of > Cartouche de > Kartusche von 400 ml & Mixer	12
	<b>747169</b>	<b>BCR 400 POLY SF-TP</b> 	Cartuccia da > Cartridge of > Cartouche de > Kartusche von 400 ml & Mixer <b>COLORE PIETRA &gt; STONE COLOUR &gt; TON PIERRE &gt; FARBIGE STEIN</b>	12
	<b>747138</b>	<b>BCR 300 POLY SF</b>	Cartuccia da > Cartridge of > Cartouche de > Kartusche von 300 ml & Mixer	15
	<b>747144</b>	<b>BCR 300 POLY SF-TP</b> 	Cartuccia da > Cartridge of > Cartouche de > Kartusche von 300 ml & Mixer <b>COLORE PIETRA &gt; STONE COLOUR &gt; TON PIERRE &gt; FARBIGE STEIN</b>	15
	<b>747116</b>	<b>TERMO 165 POLY SF</b>	Confezionamento con foglio termico > Thermo foil packed Emballage avec feuil thermique > Thermo- Folienverpackung	12
	<b>747199</b>	<b>OSR 400 POLY SF SECCHIO</b>	12 x cartucce, 1 x pompa, 24 x mixers 12 x cartridges, 1 x gun, 24 x mixers 12 x cartouches, 1 x pompe, 24 x mixers 12 x Kartuschen, 1 x Auspresspistole, 24 x Mischer	1
	<b>747197</b>	<b>OSR 300 POLY SF SECCHIO</b>	18 x cartucce, 1 x pompa, 36 x mixers 18 x cartridges, 1 x gun, 36 x mixers 18 x cartouches, 1 x pompe, 36 x mixers 18 x Kartuschen, 1 x Auspresspistole, 36 x Mischer	1
	<b>747198</b>	<b>OSR 400 POLY SF SECCHIO NP-2M</b>	12 x cartucce, 24 x mixers > 12 x cartridges, 24 x mixers 12 x cartouches, 24 x mixers > 12 x Kartuschen, 24 x Mischer	1
	<b>747196</b>	<b>OSR 300 POLY SF SECCHIO NP-2M</b>	18 x cartucce, 36 x mixers > 18 x cartridges, 36 x mixers 18 x cartouches, 36 x mixers > 18 x Kartuschen, 36 x Mischer	1
	<b>747201</b>	<b>BOX 400 POLY SF</b>	20 x cartucce, 40 x mixers > 20 x cartridges, 40 x mixers 20 x cartouches, 40 x mixers > 20 x Kartuschen, 40 x Mischer	1
	<b>747200</b>	<b>BOX 300 POLY SF</b>	30 x cartucce, 60 x mixers > 30 x cartridges, 60 x mixers 30 x cartouches, 60 x mixers > 30 x Kartuschen, 60 x Mischer	1

Secondo mixer > Additional mixer  
Deuxieme mixer > Doppelmischer



CODICE CARTUCCIA > CODE CARTRIDGE  
CODE CARTOUCHE > KARTUSCHE NUMBER  
**000000AX**

 Prodotto su richiesta, ordini programmati legati a quantità MINIME  
On demand product; order planning required in connection with specific quantities.  
Produit sur requête; planification des commande nécessaire dans le cadre de quantités spécifiques  
On Demand-Produkt; Auftragsplanung erforderlich in Verbindung mit spezifischen Mengen.

## Tempi di posa | Setting times | Temps d'installation | Verlegungszeit



### POLYSF



	01	02	03
			
30 °C	3 min	20 min	
25 °C	4 min	30 min	
20 °C	6 min	45 min	
10 °C	12 min	1 h 30'	
5 °C	15 min	2 hours	
0 °C	25 min	3 hours	

**+5°C**  
Temperatura minima del prodotto per l'applicazione  
Minimum product temperature for application  
Température minimal de la cartouche pour l'application  
Min Kartouchetemperatur für die Anwendung

**ASCIUTTO | DRY | SEC | TROCKENEM**

- 01 Temperatura supporto > Base material temperature  
Temperature material de base > Grundmaterial-temperatur
- 02 Tempo di lavorabilità > Open time > Temps de manipulation > Verarbeitungszeit
- 03 Attesa per la messa in carico > Curing time > Temps avant l'application de charge > Bauzeit



## Numero fissaggi | Number of fixings | Nombre de fixations | Anzahl der Befestigungen

Fissaggi nei materiali pieni > Fixings in solid materials > Fixations dans matériaux pleins > Befestigungen in vollsteinen



BARRA FILETTATA > THREADED STUD BARRE FILETÉE > GEWINDESTANGE	FORO > HOLE TROU > BOHRLOCH	BCR 165	BCR 300	BCR 400
 d <sub>nom</sub> [mm]	d <sub>o</sub> [mm] x h <sub>1</sub> [mm]	Nr. Fissaggi > Fixings	Nr. Fissaggi > Fixings	Nr. Fissaggi > Fixings
M 8	10 x 90	± 30	± 54	± 72
M 10	12 x 95	± 21	± 39	± 52
M 12	14 x 115	± 14	± 25	± 34
M 16	18 x 130	± 9	± 16	± 21
M 20	24 x 175	± 3	± 6	± 7
M 24	28 x 215	± 2	± 4	± 5

Fissaggi nei materiali forati > Fixings in hollow materials > Fixations dans matériaux creux > Befestigungen in lochsteinen



BARRA FILETTATA > THREADED STUD BARRE FILETÉE > GEWINDESTANGE	BCR 165	BCR 300	BCR 400	GABBIETTA > SLEEVE TAMIS > HÜLSE
 d <sub>nom</sub> [mm]	Nr. Fissaggi > Fixings	Nr. Fissaggi > Fixings	Nr. Fissaggi > Fixings	d <sub>nom</sub> [mm] x L [mm]
M 8	± 15	± 27	± 35	GC 12 x 80
M 8	± 9	± 16	± 21	GC 15 x 85
M 10	± 9	± 16	± 21	GC 15 x 85
M 12	± 9	± 16	± 21	GC 15 x 85
M 12	± 5	± 9	± 12	GC 20 x 85
M 16	± 5	± 9	± 12	GC 20 x 85

- > **NOTA:** Il numero di fissaggi sopra specificato è stato determinato conteggiando esclusivamente il volume teorico di prodotto necessario al riempimento del foro (o gabbietta) escluso il volume della barra inserita. Pur essendo incluso nel calcolo teorico uno spreco standard, il reale quantitativo di prodotto potrà differire da questo in funzione della effettiva modalità di posa in opera adottata.
- > **WARNING:** The number of fixings above mentioned has been calculated according to the theoretical volume needed to fill the hole (or sleeve) excluded the volume of the inserted metal rod. In the theoretical volume it is included a standard extra quantity but the real quantity of the product may be different than it in function of the real application of the product.
- > **NOTE:** Le numéro des fixations sur mentionné a été déterminé en calculant exclusivement le volume théorique de produit nécessaire au remplissage du trou (ou tamis), exclu le volume de la tige filetée. Bien si dans le calcul théorique est incluse une quantité standard de matériel extra, la quantité réelle de produit peut être différente, en fonction des effectives modes d'application du produit.
- > **ANMERKUNG:** Die obengenannte Anzahl der Befestigungen wurde nach dem theoretischen Volumen für die Bohrlochfüllung (oder Siebhülse-Füllung) minus dem Volumen der Gewindestange berechnet. Im theoretischen Volumen wird eine Standard-Extra-Menge einkalkuliert, aber die wirkliche Produktmenge kann anders sein, abhängig von der wirklichen Anwendung des Produktes.



# SCHEDA TECNICA TECHNICAL DATA SHEET FICHE TECHNIQUE TECHNISCHES DATENBLATT

## Dati installazione | Installation data | Données d'installation | Installationsangaben

<b>D</b>	Materiale > Material > Matériel > Material
	d [mm] Diametro barra > Rod diameter > Diamètre de la barre > Stangedurchmesser
<b>N</b>	Tipologia di barra > Type of rod > Barre classe > Stange Klasse
	Gabbietta > Plastic sleeve > Tamis > Hülle
<b>E</b>	h <sub>min</sub> [mm] Spessore minimo del supporto > Minimum thickness of base material Épaisseur Minimal du Matière Base > Mindestbauteildicke
<b>G</b>	d <sub>0</sub> [mm] Diametro foro > Hole diameter > Diamètre du trou > Bohrlochennendurchmesser
	h <sub>1</sub> [mm] Profondità del foro > Hole depth > Profondeur du trou > Bohrlochtiefe
<b>L</b>	h <sub>nom</sub> [mm] Profondità di inserimento > Embedment depth Profondeur d'enfocé > Setztiefe
	h <sub>ef</sub> [mm] Profondità effettiva ancoraggio > Effective anchorage depth Profondeur efficace d'ancrage > Effektive Verankerungstiefe

<b>D</b>	S <sub>cr</sub> [mm] Interasse caratteristico > Characteristic spacing Entraxe Caractéristique > Charakteristische Achsabstand
	C <sub>cr</sub> [mm] Distanza dal bordo caratteristica > Characteristic edge distance Distance du bord caractéristique > Charakteristische Randabstand
<b>N</b>	S <sub>min</sub> [mm] Interasse minimo > Minimum allowable spacing Entraxe minimale > Minimaler Achsabstand
	C <sub>min</sub> [mm] Distanza minima dal bordo > Minimum allowable edge distance Distance du bord minimale > Minimaler Randabstand
<b>G</b>	t <sub>fix</sub> [mm] Spessore fissabile > Fixture thickness Épaisseur fixable > Anbauteildicke
<b>L</b>	d <sub>f</sub> [mm] Diametro foro spessore fissabile > Diameter of clearance hole in the fixture Diamètre du trou de épaisseur fixable > Durchgangsloch im Anbauteil
	S <sub>w</sub> [mm] Chiave > Key > Clef > Schlüsselweite
<b>L</b>	T <sub>inst</sub> [Nm] Coppia di serraggio > Installation torque Couple de serrage > Drehmoment Beim Verankern

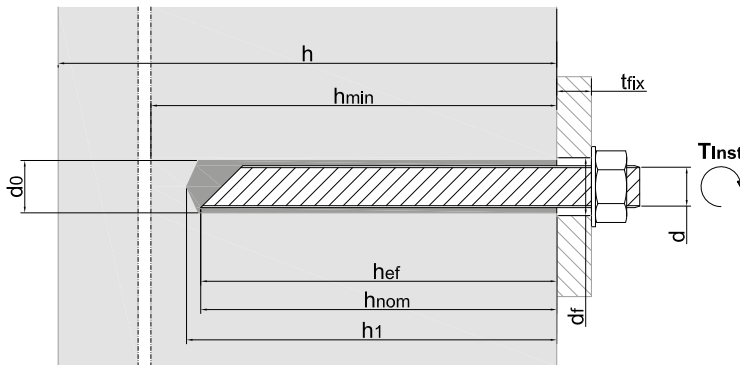

- > **NOTA:** Prima dell'installazione del prodotto consultare la presente sezione e la procedura di installazione completa riportata nelle pagine successive. Si declina ogni responsabilità per l'uso improprio del prodotto.
- > **WARNING:** Before use see this section and the complete procedure of installation reported in the next pages. We assume no liability for the not correct use of the product.
- > **NOTE:** avant l'installation du produit nous vous prions de lire cette section et la procédure d'installation complète que Vous trouvez dans les pages suivantes. Nous n'assumons pas de responsabilité pour une utilisation incorrecte du produit.
- > **ANMERKUNG:** vor der Installation des Produktes bitte diesen Abschnitt und das komplette Installationsverfahren in den folgenden Seiten lesen. Wir übernehmen keine Haftung für die inkorrekte Anwendung des Produktes.



Opzione > Option 7

M8 ... M16



MATERIALE MATERIAL	DIAMETRO BARRA ROD DIAMETER	TIPOLOGIA DI BARRA TYPE OF ROD	SPESSORE MIN. DEL SUPPORTO MIN. THICKNESS BASE MATERIAL			DIAMETRO FORO HOLE DIAMETER	PROFONDITÀ DEL FORO HOLE DEPTH			PROFONDITÀ DI INSERIMENTO EMBEDMENT DEPTH			PROFONDITÀ EFF. ANCORAGGIO EFFECTIVE ANCHORAGE DEPTH			INTERASSE CARATTERISTICO CHARACTERISTIC SPACING			DISTANZA DAL BORDO CARATTERISTICA CHARACTERISTIC EDGE DISTANCE		
			min	med	max		min	med	max	min	med	max	min	med	max	min	med	max	min	med	max
 M8-M16 Calcestruzzo non fessurato Non cracked Concrete	d [mm]		h <sub>min</sub> [mm]			d <sub>0</sub> [mm]	h <sub>1</sub> [mm]			h <sub>nom</sub> [mm]			h <sub>ef</sub> [mm]			S <sub>cr.N</sub> [mm]			C <sub>cr.N</sub> [mm]		
	M8	≥ 5.8 A4-70	100	110	190	10	65	85	165	60	80	160	60	80	160	180	202	202	90	101	101
	M10	≥ 5.8 A4-70	100	120	230	12	75	95	205	70	90	200	70	90	200	210	253	253	105	126	126
	M12	≥ 5.8 A4-70	110	140	270	14	85	115	245	80	110	240	80	110	240	240	291	291	120	145	145
	M16	≥ 5.8 A4-70	136	161	356	18	105	130	325	100	125	320	100	125	320	300	351	351	150	175	175
	M20*	≥ 5.8 A4-70	168	218	448	24	125	175	405	120	170	400	120	170	400	360	450	450	180	225	225
M24*	≥ 5.8 A4-70	201	266	536	28	150	215	485	145	210	480	145	210	480	435	540	540	218	270	270	

(\*) Diametri senza omologazione ETA-CE > Diameters without ETA-CE approval > Diamètres sans approbation ATE-CE > Durchmesser ohne ETA-CE-Zulassung



Opzione > Option 7

M8 ... M16



MATERIALE MATERIAL	DIAMETRO BARRA ROD DIAMETER	TIPOLOGIA DI BARRA TYPE OF ROD	INTERASSE MIN. ALLOWABLE SPACING	DISTANZA MIN. DAL BORDO MIN. ALLOWABLE EDGE DISTANCE	SPESS. FISSABILE FIXTURE THICKNESS	DIAMETRO FORO SP. DIAMETER OF CLEARANCE HOLE IN THE FIXTURE	CHIAVE KEY	COPIA DI SERRAGGIO INSTALLATION TORQUE
<b>POLYSF</b>	d [mm]		S <sub>min</sub> [mm]	C <sub>min</sub> [mm]	t <sub>fix</sub> [mm]	d <sub>r</sub> [mm]	S <sub>w</sub> [mm]	T <sub>inst</sub> [Nm]
 M8-M16 Calcestruzzo non fessurato Non cracked Concrete	M8	≥ 5.8 A4-70	40	40	0 ÷ 1500	9	13	10
	M10	≥ 5.8 A4-70	40	40	0 ÷ 1500	12	17	20
	M12	≥ 5.8 A4-70	40	40	0 ÷ 1500	14	19	40
	M16	≥ 5.8 A4-70	50	50	0 ÷ 1500	18	24	80
	M20*	≥ 5.8 A4-70	60	60	0 ÷ 1500	22	30	130
	M24*	≥ 5.8 A4-70	80	80	0 ÷ 1500	26	36	200

> Per evitare una possibile rottura per splitting, lo spessore del supporto in calcestruzzo dovrà essere h ≥ 2h<sub>ef</sub>  
 > To avoid splitting failure, the thickness of the concrete member shall be h ≥ 2h<sub>ef</sub>  
 > Pour éviter une possible rupture par splitting, l'épaisseur du support en béton devrait être h ≥ 2h<sub>ef</sub>  
 > Um einen splittingbedingten Bruch zu verhindern, die Dicke der Unterlage aus Beton muss h ≥ 2h<sub>ef</sub> sein

(\*) Diametri senza omologazione ETA-CE > Diameters without ETA-CE approval  
 Diamètres sans approbation ATE-CE > Durchmesser ohne ETA-CE-Zulassung



ETAG - 029 Muratura > Masonry

Barra filettata > Threaded rod  
 M8-M10-M12

Gabbiette > Sleeves

GC 12x80 - GC 15x85 - GC 20x85

M8 - M10 - M12

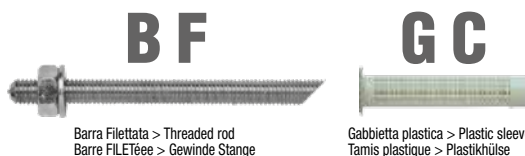

Barra Filettata > Threaded rod  
 Barre FILETées > Gewinde Stange

Gabbietta plastica > Plastic sleeve  
 Tamis plastique > Plastikhülse

MATERIALE MATERIAL	DIAMETRO BARRA ROD DIAMETER	TIPOLOGIA DI BARRA TYPE OF ROD	SPessore MIN. DEL SUPPORTO MIN. THICKNESS BASE MATERIAL	DIAMETRO FORO HOLE DIAMETER	PROFONDITÀ DEL FORO HOLE DEPTH	PROFONDITÀ DI INSERIMENTO EMBEDMENT DEPTH	PROFONDITÀ EFF. ANCORAGGIO EFFECTIVE ANCHORAGE DEPTH	INTERASSE CARATTERISTICO CHARACTERISTIC SPACING	DISTANZA DAL BORDO CARATTERISTICA CHARACTERISTIC EDGE DISTANCE	INTERASSE MIN. ALLOWABLE SPACING	DISTANZA MIN. DAL BORDO MIN. ALLOWABLE EDGE DISTANCE	SPESS. FISSABILE FIXTURE THICKNESS	DIAMETRO FORO SP. DIAMETER OF CLEARANCE HOLE IN THE FIXTURE	CHIAVE KEY	COPIA DI SERRAGGIO INSTALLATION TORQUE
	d [mm]		h <sub>min</sub> [mm]	d <sub>0</sub> [mm]	h <sub>1</sub> [mm]	h <sub>nom</sub> [mm]	h <sub>ef</sub> [mm]	S <sub>cr</sub> [mm]	C <sub>cr</sub> [mm]	S <sub>min</sub> [mm]	C <sub>min</sub> [mm]	t <sub>fix</sub> [mm]	d <sub>r</sub> [mm]	S <sub>w</sub> [mm]	T <sub>inst</sub> [Nm]
 Mattone pieno Solid Brick Brique pleine Vollmauerwerk	M8	≥ 5.8 A4-70	200	10	85	80	80	240	120	240	120	10	9	13	5
	M10	≥ 5.8 A4-70	250	12	90	85	85	255	128	255	128	20	12	17	8
	M12	≥ 5.8 A4-70	300	14	100	95	95	285	143	285	143	30	14	19	10

MATERIALE MATERIAL	DIAMETRO BARRA ROD DIAMETER	TIPOLOGIA DI BARRA TYPE OF ROD	GABBETTA PLASTIC SLEEVE	SPessore MIN. DEL SUPPORTO MIN. THICKNESS BASE MATERIAL	DIAMETRO FORO HOLE DIAMETER	PROFONDITÀ DEL FORO HOLE DEPTH	PROFONDITÀ DI INSERIMENTO EMBEDMENT DEPTH	PROFONDITÀ EFF. ANCORAGGIO EFFECTIVE ANCHORAGE DEPTH	INTERASSE CARATTERISTICO CHARACTERISTIC SPACING	DISTANZA DAL BORDO CARATTERISTICA CHARACTERISTIC EDGE DISTANCE	INTERASSE MIN. ALLOWABLE SPACING	DISTANZA MIN. DAL BORDO MIN. ALLOWABLE EDGE DISTANCE	SPESS. FISSABILE FIXTURE THICKNESS	DIAMETRO FORO SP. DIAMETER OF CLEARANCE HOLE IN THE FIXTURE	CHIAVE KEY	COPIA DI SERRAGGIO INSTALLATION TORQUE
	d [mm]		(*)	h <sub>min</sub> [mm]	d <sub>0</sub> [mm]	h <sub>1</sub> [mm]	h <sub>nom</sub> [mm]	h <sub>ef</sub> [mm]	S <sub>cr</sub> [mm]	C <sub>cr</sub> [mm]	S <sub>min</sub> [mm]	C <sub>min</sub> [mm]	t <sub>fix</sub> [mm]	d <sub>r</sub> [mm]	S <sub>w</sub> [mm]	T <sub>inst</sub> [Nm]
 Mattone forato Hollow Brick Brique creux Lochziegel	M8	≥ 5.8 A4-70	GC 12x80	100	12	85	80	80	l <sub>unit,max</sub>	0,5 x l <sub>unit,max</sub>	100	100	10	9	13	3
	M10	≥ 5.8 A4-70	GC 15x85	100	16	90	85	85	l <sub>unit,max</sub>	0,5 x l <sub>unit,max</sub>	100	100	20	12	17	4
	M12	≥ 5.8 A4-70	GC 20x85	100	20	90	85	85	l <sub>unit,max</sub>	0,5 x l <sub>unit,max</sub>	120	120	30	14	19	6

(\*) Altre lunghezze disponibili, vedi catalogo > Other lengths available see catalogue

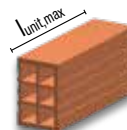

l<sub>unit,max</sub> = Massima dimensione del blocco di muratura  
 Max length of masonry unit  
 Dimension maximale du bloc de maçonnerie  
 Maximale Größe des Ziegelsteins



# SCHEDA TECNICA TECHNICAL DATA SHEET FICHE TECHNIQUE TECHNISCHES DATENBLATT

## Dati carico | Load data | Données de charge | Lastdaten

<b>D N E G L</b>	<b>N<sub>rum</sub></b> [kN]	Carico ultimo medio a trazione > Average ultimate tension load > Charge maximum moyenne de traction Durchschnittliche maximale Zuglast
	<b>V<sub>rum</sub></b> [kN]	Carico ultimo medio a taglio > Average ultimate shear load > Charge maximum moyenne de cisaillement Durchschnittliche maximale Querlast
	<b>N<sub>rk</sub></b> [kN]	Carico caratteristico a trazione > Characteristic tension load > Charge caractéristique de traction Charakteristische Zuglast
	<b>V<sub>rk</sub></b> [kN]	Carico caratteristico a taglio > Characteristic shear load > Charge caractéristique de cisaillement Charakteristische Querlast
	<b>N<sub>rec</sub></b> [kN]	Carico ammissibile a trazione > Admissible tensile load > Charge admissible de traction > Zulässige Zuglast
	<b>V<sub>rec</sub></b> [kN]	Carico ammissibile a taglio > Admissible shear load > Charge admissible de cisaillement > Zulässige Querlast



> Carichi validi per singolo ancorante senza influenza di interasse e distanza dal bordo e  $h \geq 2h_{ef}$  > 1kN = 100 Kg  
 > Loads for single anchor with no influence of spacing and edge distance and with  $h \geq 2h_{ef}$  >  $\psi_{bas} = 1,0$   
 > Charges valables pour chaque ancrage sans influence d'interaxe et distance du bord et  $h \geq 2h_{ef}$   
 > Passende Ringe für den einzelnen Veranker, ohne Achsenabstandseinfluss und des Randabstands und  $h \geq 2h_{ef}$

> Azione di taglio non diretta verso il bordo > Coefficiente di sicurezza globale incluso > Coefficiente lato carichi utilizzato = 1,4  
 > Shear directed away from the edge > General safety factor included > Load increasing safety coefficient used = 1,4  
 > Action de cisaillement pas dirigée vers le bord > Coefficient de sécurité générale inclu > Coefficient côté charge utilisé = 1,4  
 > Queraktion nicht an den Rand gerichtet > Generelle Sicherheitskoeffizient inbegriffen > Verwendeter Lasterhöhungssicherheitskoeffizient = 1,4

## MIN Dati di carico con profondità effettiva ancoraggio MINIMA > Load data with MINIMUM effective anchorage depth Donnes de charge avec profondeur efficace d'ancrage MINIMALE > Lastdaten mit MINIMALER effektiven Verankerungstiefe



MATERIALE MATERIAL	BARRA ROD	DIAMETRO BARRA ROD DIAMETER	PROFONDITÀ EFF. ANCORAGGIO EFFECTIVE ANCHORAGE DEPTH	CARICO ULTIMO MEDIO A TRAZIONE ULTIMATE TENSION LOAD	CARICO ULTIMO MEDIO A TAGLIO ULTIMATE SHEAR LOAD	CARICO CARATTERISTICO A TRAZIONE CHARACTERISTIC TENSILE LOAD	CARICO CARATTERISTICO A TAGLIO CHARACTERISTIC SHEAR LOAD	CARICO AMMISSIBILE A TRAZIONE ADMISSIBLE TENSILE LOAD	CARICO AMMISSIBILE A TAGLIO ADMISSIBLE SHEAR LOAD
				N <sub>rum</sub> [kN]	V <sub>rum</sub> [kN]	N <sub>rk</sub> [kN]	V <sub>rk</sub> [kN]	N <sub>rec</sub> [kN]	V <sub>rec</sub> [kN]
<b>C20/25 Calcestruzzo non fessurato Non cracked Concrete Beton non fissuré Ungerissener Beton</b> 	≥ 5.8	M 8	60	19,0	11,4	19,0	9,5	7,5	5,4
		M 10	70	30,2	18,1	27,4	15,1	10,9	8,6
		M 12	80	39,7	26,3	33,8	21,9	13,4	12,5
		M 16	100	56,4	48,9	47,0	40,8	18,6	23,3
		M 20*	120	64,1	76,2	52,6	63,5	20,9	36,2
		M 24*	145	82,0	110,4	67,3	92,0	26,7	52,5

## MED Dati di carico con profondità effettiva ancoraggio MEDIA > Load data with MEDIUM effective anchorage depth Donnes de charge avec profondeur efficace d'ancrage MOYENNE > Lastdaten mit MITTLERER effektiven Verankerungstiefe



MATERIALE MATERIAL	BARRA ROD	DIAMETRO BARRA ROD DIAMETER	PROFONDITÀ EFF. ANCORAGGIO EFFECTIVE ANCHORAGE DEPTH	CARICO ULTIMO MEDIO A TRAZIONE ULTIMATE TENSION LOAD	CARICO ULTIMO MEDIO A TAGLIO ULTIMATE SHEAR LOAD	CARICO CARATTERISTICO A TRAZIONE CHARACTERISTIC TENSILE LOAD	CARICO CARATTERISTICO A TAGLIO CHARACTERISTIC SHEAR LOAD	CARICO AMMISSIBILE A TRAZIONE ADMISSIBLE TENSILE LOAD	CARICO AMMISSIBILE A TAGLIO ADMISSIBLE SHEAR LOAD
				N <sub>rum</sub> [kN]	V <sub>rum</sub> [kN]	N <sub>rk</sub> [kN]	V <sub>rk</sub> [kN]	N <sub>rec</sub> [kN]	V <sub>rec</sub> [kN]
<b>C20/25 Calcestruzzo non fessurato Non cracked Concrete Beton non fissuré Ungerissener Beton</b> 	≥ 5.8	M 8	80	19,0	11,4	19,0	9,5	9,0	5,4
		M 10	90	30,2	18,1	30,2	15,1	14,0	8,6
		M 12	110	43,8	26,3	43,8	21,9	18,4	12,5
		M 16	125	70,5	48,9	58,7	40,8	23,3	23,3
		M 20*	170	90,8	76,2	74,5	63,5	29,6	36,2
		M 24*	210	118,8	110,4	97,5	92,0	38,7	52,5

## MAX Dati di carico con profondità effettiva ancoraggio MASSIMO > Load data with MAXIMUM effective anchorage depth Donnes de charge avec profondeur efficace d'ancrage MAXIMUM > Lastdaten mit MAXIMALER effektiven Verankerungstiefe



MATERIALE MATERIAL	BARRA ROD	DIAMETRO BARRA ROD DIAMETER	PROFONDITÀ EFF. ANCORAGGIO EFFECTIVE ANCHORAGE DEPTH	CARICO ULTIMO MEDIO A TRAZIONE ULTIMATE TENSION LOAD	CARICO ULTIMO MEDIO A TAGLIO ULTIMATE SHEAR LOAD	CARICO CARATTERISTICO A TRAZIONE CHARACTERISTIC TENSILE LOAD	CARICO CARATTERISTICO A TAGLIO CHARACTERISTIC SHEAR LOAD	CARICO AMMISSIBILE A TRAZIONE ADMISSIBLE TENSILE LOAD	CARICO AMMISSIBILE A TAGLIO ADMISSIBLE SHEAR LOAD
				N <sub>rum</sub> [kN]	V <sub>rum</sub> [kN]	N <sub>rk</sub> [kN]	V <sub>rk</sub> [kN]	N <sub>rec</sub> [kN]	V <sub>rec</sub> [kN]
<b>C20/25 Calcestruzzo non fessurato Non cracked Concrete Beton non fissuré Ungerissener Beton</b> 	8.8	M 8	160	29,2	17,5	29,2	14,6	13,9	8,3
		M 10	200	46,4	27,8	46,4	23,2	22,1	13,2
		M 12	240	67,4	40,4	67,4	33,7	32,1	19,2
		M 16	320	125,0	75,0	125,0	62,5	59,5	35,7
		M 20*	400	203,0	121,8	175,4	101,5	69,6	58,0
		M 24*	480	271,4	175,8	222,9	146,5	88,5	83,7

(\* Diametri senza omologazione ETA-CE > Diameters without ETA-CE approval > Diamètres sans approbation ETE-CE > Durchmesser ohne ETA-CE-Zulassung







**Dati carico | Load data | Données de charge | Lastdaten**





- > Vista la varietà dei substrati in muratura per applicazioni su supporti differenti da quelli considerati, i valori di carico dovranno essere ricavati tramite opportune prove in situ.
- > For different masonry base materials, load values must be obtained with in situ tests.
- > En considération de la variété des matériaux de base en maçonnerie, pour des applications sur matériaux de base différents de ceux considérés les valeurs de charge doivent être déterminées au moyen de tests in situ.
- > In Anbetracht der Vielzahl von Basismaterialien in Mauerwerk, für Anwendungen auf Basismaterialien unterschiedlich von denen, die geprüft wurden, sollten die Last-Werte durch Tests in situ bestimmt werden.





	MATERIALE MATERIAL	TIPOLOGIA DI BARRA TYPE OF ROD	DIAMETRO BARRA ROD DIAMETER	CARICO AMMISSIBILE A TRAZIONE ADMISSIBLE TENSILE LOAD	CARICO AMMISSIBILE A TAGLIO ADMISSIBLE SHEAR LOAD
			d [mm]	N <sub>rec</sub> [kN]	V <sub>rec</sub> [kN]
 <b>Mattone Pieno</b> <b>EN 771-1 - HD (High Density)</b> Dimensions: 120x240x60 mm class f <sub>b</sub> ≥ 73 N/mm <sup>2</sup> density ρ <sub>m</sub> ≥ 1700 kg/m <sup>3</sup>  <b>≥ 5.8 / A4-70</b>		≥ 5.8 A4 -70	M8	0,7	1,3
		≥ 5.8 A4 -70	M10	1,0	2,5
		≥ 5.8 A4 -70	M12	1,2	2,6



	MATERIALE MATERIAL	TIPOLOGIA DI BARRA TYPE OF ROD	DIAMETRO BARRA ROD DIAMETER	GABBIETTA PLASTIC SLEEVE	CARICO AMMISSIBILE A TRAZIONE ADMISSIBLE TENSILE LOAD	CARICO AMMISSIBILE A TAGLIO ADMISSIBLE SHEAR LOAD
			d [mm]		N <sub>rec</sub> [kN]	V <sub>rec</sub> [kN]
 <b>Mattone Doppio UNI</b> <b>EN 771-1 - LD (Low Density)</b> Dimensions: 240 x 120 x 120 mm class f <sub>b</sub> ≥ 18,3 N/mm <sup>2</sup> density ρ <sub>m</sub> ≥ 810 kg/m <sup>3</sup>  <b>≥ 5.8 / A4-70</b>		≥ 5.8 A4 -70	M8	GC 12 x 80	1,5	1,7
		≥ 5.8 A4 -70	M10	GC 15 x 85	1,8	2,0
		≥ 5.8 A4 -70	M12	GC 20 x 85	2,1	2,9

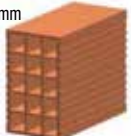

	MATERIALE MATERIAL	TIPOLOGIA DI BARRA TYPE OF ROD	DIAMETRO BARRA ROD DIAMETER	GABBIETTA PLASTIC SLEEVE	CARICO AMMISSIBILE A TRAZIONE ADMISSIBLE TENSILE LOAD	CARICO AMMISSIBILE A TAGLIO ADMISSIBLE SHEAR LOAD
			d [mm]		N <sub>rec</sub> [kN]	V <sub>rec</sub> [kN]
 <b>Forato</b> <b>EN 771-1 - LD (Low Density)</b> Dimensions: 120 x 250 x 250 mm class f <sub>b</sub> ≥ 5,3 N/mm <sup>2</sup> density ρ <sub>m</sub> ≥ 550 kg/m <sup>3</sup>  <b>≥ 5.8 / A4-70</b>		≥ 5.8 A4 -70	M8	GC 12 x 80	0,3	0,9
		≥ 5.8 A4 -70	M10	GC 15 x 85	0,7	0,9
		≥ 5.8 A4 -70	M12	GC 20 x 85	0,8	0,9





# SCHEDA TECNICA TECHNICAL DATA SHEET FICHE TECHNIQUE TECHNISCHES DATENBLATT

## Dati carico | Load data | Données de charge | Lastdaten





- > Vista la varietà dei substrati in muratura per applicazioni su supporti differenti da quelli considerati, i valori di carico dovranno essere ricavati tramite opportune prove in situ.
- > For different masonry base materials, load values must be obtained with in situ tests.
- > En considération de la variété des matériaux de base en maçonnerie, pour des applications sur matériaux de base différents de ceux considérés les valeurs de charge doivent être déterminées au moyen de tests in situ.
- > In Anbetracht der Vielzahl von Basismaterialien in Mauerwerk, für Anwendungen auf Basismaterialien unterschiedlich von denen, die geprüft wurden, sollten die Last-Werte durch Tests in situ bestimmt werden.





	MATERIALE MATERIAL	TIPOLOGIA DI BARRA TYPE OF ROD	DIAMETRO BARRA ROD DIAMETER	GABBIETTA PLASTIC SLEEVE	CARICO AMMISSIBILE A TRAZIONE ADMISSIBLE TENSILE LOAD	CARICO AMMISSIBILE A TAGLIO ADMISSIBLE SHEAR LOAD	
			d [mm]		N <sub>rec</sub> [kN]	V <sub>rec</sub> [kN]	
<b>Brique creouse RC 40</b> <b>EN 771-1 - LD (Low Density)</b> Dimensions: 555 x 195 x 275 mm class f <sub>b</sub> ≥ 4 N/mm <sup>2</sup> density ρ <sub>m</sub> ≥ 600 kg/m <sup>3</sup> <b>≥ 5.8 / A4-70</b>		≥ 5.8 A4 -70	M8		GC 12 x 80	0,3	0,4
		≥ 5.8 A4 -70	M10		GC 15 x 85	0,3	0,4
		≥ 5.8 A4 -70	M12		GC 20 x 85	0,3	0,4



	MATERIALE MATERIAL	TIPOLOGIA DI BARRA TYPE OF ROD	DIAMETRO BARRA ROD DIAMETER	GABBIETTA PLASTIC SLEEVE	CARICO AMMISSIBILE A TRAZIONE ADMISSIBLE TENSILE LOAD	CARICO AMMISSIBILE A TAGLIO ADMISSIBLE SHEAR LOAD	
			d [mm]		N <sub>rec</sub> [kN]	V <sub>rec</sub> [kN]	
<b>Porotherm 25 P+W</b> <b>EN 771-1 - LD (Low Density)</b> Dimensions: 373 x 238 x 250 mm class f <sub>b</sub> ≥ 15 N/mm <sup>2</sup> density ρ <sub>m</sub> ≥ 800 kg/m <sup>3</sup> <b>≥ 5.8 / A4-70</b>		≥ 5.8 A4 -70	M8		GC 12 x 80	0,9	0,8
		≥ 5.8 A4 -70	M10		GC 15 x 85	0,9	1,0
		≥ 5.8 A4 -70	M12		GC 20 x 85	1,0	1,0



	MATERIALE MATERIAL	TIPOLOGIA DI BARRA TYPE OF ROD	DIAMETRO BARRA ROD DIAMETER	GABBIETTA PLASTIC SLEEVE	CARICO AMMISSIBILE A TRAZIONE ADMISSIBLE TENSILE LOAD	CARICO AMMISSIBILE A TAGLIO ADMISSIBLE SHEAR LOAD	
			d [mm]		N <sub>rec</sub> [kN]	V <sub>rec</sub> [kN]	
<b>Hlz B - 1.0 1NF 12-1</b> <b>EN 771-1 - LD (Low Density)</b> Dimensions: 115 x 240 x 71 mm class f <sub>b</sub> ≥ 12 N/mm <sup>2</sup> density ρ <sub>m</sub> ≥ 900 kg/m <sup>3</sup> <b>≥ 5.8 / A4-70</b>		≥ 5.8 A4 -70	M8		GC 12 x 80	1,2	1,3
		≥ 5.8 A4 -70	M10		GC 15 x 85	1,7	1,7
		≥ 5.8 A4 -70	M12		GC 20 x 85	1,8	1,7



## CHEMICAL ANCHOR FOR CONCRETE, SOLID AND HOLLOW/PERFORATED MASONRY

Ancorante chimico per calcestruzzo, muratura di mattoni pieni e forati > Scellements chimique à injection pour béton, briques pleines et percées > Chemische verankerung für Beton, voll- und Lochziegel





# INSTALLATION

PROCEDURA DI INSTALLAZIONE  
INSTALLATION PROCEDURE  
PROCÉDURE D'INSTALLATION  
INSTALLATIONSVERFAHREN

## 01 PULIZIA | CLEANING | NETTOYAGE | REINIGUNG

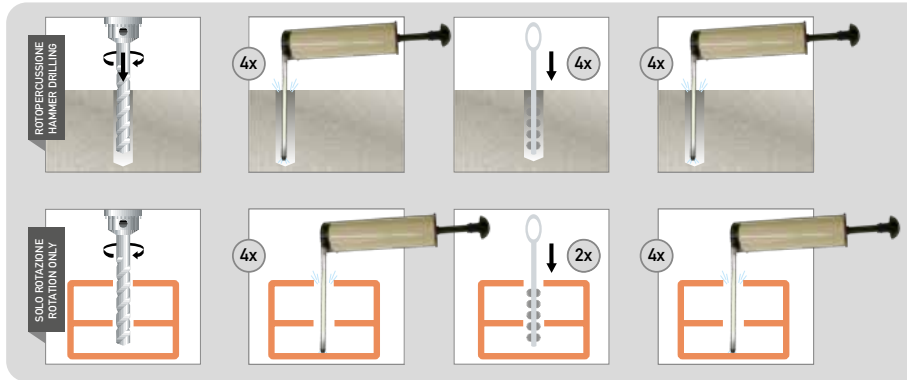

Eseguire il foro controllandone la perpendicolarità. Soffiare il foro con apposita pompa soffiante (o aria compressa), eseguire operazione di pulizia della superficie laterale del foro con apposito scovolino metallico, soffiare nuovamente il foro fino a che non fuoriesca più polvere e/o altro materiale residuo. Si raccomanda un'attenta pulizia della superficie laterale del foro con scovolino metallico.

Drill the hole and check it's perpendicularity. Blow the hole with an appropriate pump blower (or compression air), clean the lateral surface of the hole with an appropriate steel brush, blow again in the hole until there is no dust and/or any residual material inside. We strongly recommend use of the steel brush to clean hole sides.

Réaliser le trou en en contrôlant la perpendicularité. Souffler dans le trou avec la pompe soufflante prévue (ou de l'air comprimé), effectuer l'opération de nettoyage de la surface latérale du trou avec un écouvillon métallique, souffler à nouveau dans le trou jusqu'à ce qu'il n'en sorte plus de poussière et/ou d'autres matières résiduelles. Nous recommandons l'utilisation d'écouvillon métallique pour le nettoyage de la surface latérale du trou.

Stellen Sie die Bohrlöschung unter Kontrolle der Rechtwinkligkeit her. Blasen Sie die Bohrlöschung mit einer entsprechenden Pumpe (oder Druckluft) durch, nehmen Sie eine Reinigung der seitlichen Oberflächen der Bohrlöschung mit einer Bürste von Metall vor, blasen Sie die Bohrlöschung erneut durch, bis kein Pulver und / oder andere Materialrückstände mehr austreten. Insbesondere ist die Benutzung der Metallbürste für die Reinigung der seitlichen Oberfläche der Bohrlöschung notwendig.

## 02 APERTURA | OPENING | OUVERTURE | ÖFFNUNG

BCR 300  
BCR 165



CARTUCCIA A SACCHETTO  
FOIL CARTRIDGE (CIC)

Togliere il tappo a pressione, avvitare il miscelatore e inserire la cartuccia nella pompa usando protezioni per mani e viso. Nei formati 300 ml e 165 ml svitare il tappo, estrarre la clip metallica secondo le seguenti operazioni: 1) Inserire il miscelatore nell'asola dell'estrattore in plastica. 2) Tirare l'estrattore per sfilare la clip metallica di chiusura del sachetto. Dopodiché avvitare il miscelatore, inserire la cartuccia nella pompa usando protezioni per mani e viso.

Remove the pressure cup, screw on the mixer and insert the cartridge in the gun. Use protections for hands and face. With the size 300 ml and 165 ml, unscrew the front cup, pull-out the steel closing clip according to the following operations: 1) Insert the mixer in the eye of the plastic extractor. 2) Pull the extractor to unhook the steel closing clip of the foil. After that, screw on the mixer and insert the cartridge in the gun. Use protections for hands and face.

Retirer le bouchon de pression, visser le mélangeur et insérer la cartouche dans la pompe en utilisant les protections pour les mains et le visage. Pour les formats 300 ml et 165 ml, dévisser le bouchon, extraire le clip métallique selon les opérations suivantes: 1) Insérer le mélangeur dans la fente de l'extracteur en plastique. 2) Tirer l'extracteur pour défaire le clip métallique de fermeture du sachet. Après cela, visser le mélangeur, insérer la cartouche dans la pompe en utilisant les protections pour les mains et le visage.

Entfernen Sie die Druckkappe, schrauben Sie den Mischer an und bringen Sie den Einsatz in der Pumpe unter Verwendung von Schutzmitteln für Hände und Gesicht an. Lösen Sie bei den Formaten zu 300 ml und 165 ml den Verschluss und ziehen Sie die Metallklemme entsprechend folgender Vorgehensweise heraus: 1) Fügen Sie den Mischer in das Langloch der Ausziehvorrichtung aus Kunststoff ein. 2) Ziehen Sie die Ausziehvorrichtung heraus, um die Metallklemme zum Verschließen des Beutels zu entfernen. Schrauben Sie dann den Mischer fest und fügen Sie den Einsatz in die Pumpe unter Verwendung von Schutzmitteln für Hände und Gesicht ein.



BCR 900 / BCR 825 / BCR 470 / BCR 400 / BCR 345 / BCR 265

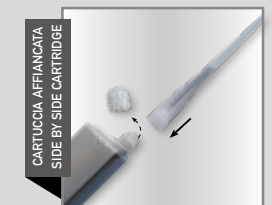

**NOTA.** Dati tecnici, di installazione e di carico possono essere oggetto di revisione. Per una versione aggiornata consultare le schede tecniche sul sito [www.bossong.com](http://www.bossong.com) o contattare il nostro Ufficio Tecnico.

**WARNING.** Installation and loads technical data can be modified by us. For update technical data sheet see [www.bossong.com](http://www.bossong.com) or be in contact with our Technical Office.

**NOTE.** Données techniques, d'installation et de charge peuvent être objet de révision. Pour une version mise à jour, consulter les fiches techniques dans le site internet [www.bossong.com](http://www.bossong.com) ou contacter notre Bureau Technique.

**ANMERKUNG.** Technische Daten, Installationsangaben und Lastdaten können modifiziert werden. Für die aktualisierte Version sind die technischen Blätter auf der Webseite [www.bossong.com](http://www.bossong.com) nachzuschauen, oder unser Technisches Büro soll konsultiert werden.

# SCHEDA TECNICA TECHNICAL DATA SHEET FICHE TECHNIQUE TECHNISCHES DATENBLATT



## 03 PREPARAZIONE DELLA CARTUCCIA | CARTRIDGE PREPARATION PREPARATION DE LA CARTOUCHE | KARTUSCHE VORBEREITUNG



Utilizzare dispenser appropriato  
Use the correct dispenser  
Utiliser un distributeur approprié  
Verwenden Sie einen geeigneten Spender

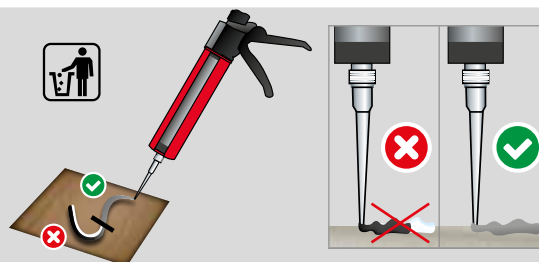

Estrudere una prima parte del prodotto assicurandosi che: 1) Attraverso il mixer (trasparente) il flusso di prodotto sia composto dalla parte A (colore bianco) e dalla parte B (colore nero). 2) I due componenti si siano completamente miscelati. La completa miscelazione è raggiunta quando dal miscelatore il prodotto, ottenuto dall'unione dei due componenti, fuoriesce con colore uniforme. Solo allora la cartuccia è pronta per l'uso.

Before starting to use the cartridge, eject a first part of the product, being sure that: 1) Through the mixer (transparent) see that the flux of product is compound of the part A (white colour) and of part B (black colour). 2) The two components are completely mixed. The complete mixing is reached only after that the product, obtained by mixing the two component, comes out from the mixer with an uniform colour. Now the cartridge is ready to be used.

Extruder une première partie du produit en s'assurant que: 1) Travers le mélangeur (transparent) le flux de produit est composé par les composants A (blanc) et B (noir). 2) Les deux composants soient complètement mélangés. Le mélange complet est atteint quand le produit obtenu par l'union des deux composants sort du mélangeur avec une couleur uniforme. Alors seulement, la cartouche est prête à l'emploi.

Ziehen Sie einen ersten Teil des Produktes heraus und prüfen Sie dass: 1) Durch den Mischer (transparent) ist der Fluss des Produktes aus Teil A (weiße Farbe) und Teil B (schwarze Farbe) zusammengesetzt. 2) Die zwei Teilen werden völlig gemischt. Die komplette Mischung erfolgt als vom Mischer das Produkt, sich ergebend von den zwei Teilen, mit gleichmäßiger Farbe entweicht. Da ist die Kartusche fertig für die Anwendung.

## 04 INIEZIONE | INJECTION | INJECTION | INJEKTION

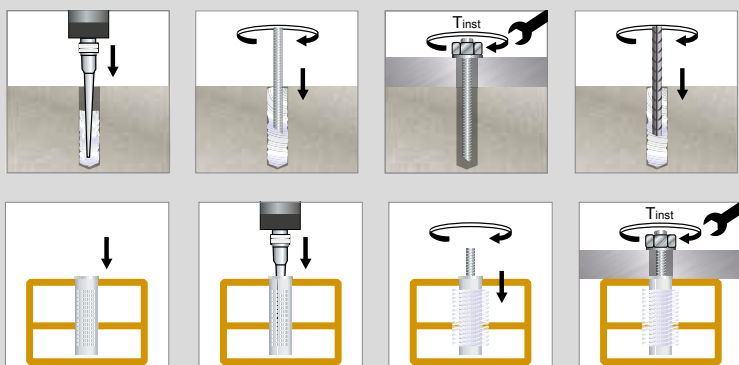

1) Estrudere la resina nel foro fino a riempirlo per 2/3. In caso di materiale forato inserire la gabbietta di plastica e poi estrarre nella gabbietta. 2) Prima di inserire la barra verificare che la superficie della stessa sia asciutta, priva di olio ed altri agenti contaminanti. Inserire la barra con un movimento rotatorio per la fuoriuscita delle bolle d'aria. 3) Per l'installazione della barra e la successiva messa in carico rispettare i relativi tempi di posa specificati sia nella scheda tecnica che sull'etichetta del prodotto. 4) Prima della messa in carico verificare l'indurimento del prodotto. 5) La cartuccia può essere riutilizzata successivamente sostituendo il mixer con uno nuovo. Ricordarsi sempre di estrarre una parte del prodotto vedi punto 3.

1) Inject resin into the hole up to fill it 2/3rds. In hollow bricks use the plastic sleeve and inject the resin inside. 2) Before insert the rod, verify that the element is dry and free oil and other contaminants. Insert threaded stud turning back and forth to avoid presence of air in the fitted hole. 3) For the installation and the following anchor load phase, respect the open time and curing time detailed in the technical data sheet and in the label of the product. 4) Before to load the anchor, check the hardened of the product. 5) The cartridge can be used again screwing the cup and replacing the mixer. Remember to eject a first part of the product, see point 3.

1) Extruder la résine dans le trou jusqu'à le remplir aux 2/3. En cas de matériel troué, insérer la forme en plastique et ensuite extruder dans la forme. 2) Avant d'insérer la barre, vérifier que la surface est sèche, sans rest de huile ou d'autres agents contaminants. Insérer la barre avec un mouvement de rotation pour faire sortir les bulles d'air. 3) Pour l'installation de la barre et le suivant chargement de l'ancrage, respecter les temps de prise indiqués sur la fiche technique et sur la cartouche. 4) Avant de charger l'ancrage, vérifier le durcissement du produit. 5) La cartouche peut être réutilisée par la suite en remplaçant le mixer par un nouveau. Se rappeler de toujours extruder une partie du produit voir point 3.

1) Pressen Sie das Harz in das Bohrloch bis diese zu 2/3 gefüllt ist. Bei Lochmaterialien muss der Siebhülse eingefügt und dann in die Hülse gepresst werden. 2) Vor dem Einstecken des Gewindestabes prüfen dass seine Fläche trocken, ohne Öl und andere verunreinigende Wirkstoffe ist. Fügen Sie den Stab mit einer Drehbewegung ein, um die Luftblasen austreten zu lassen. 3) Warten Sie die Aushärtezeit und Verladungszeit ab, die im technischen Datenblatt und auf dem Etikett des Produktes angegeben sind. 4) Vor der Verladung überprüfen dass das Produkt verhärtet ist. 5) Der Einsatz kann später wiederverwendet werden, indem der Mischer durch einen neuen ersetzt wird. Vergessen Sie nicht, immer einen Teil des Produktes herauszupressen, siehe Punkt 3.

## i CONSUMPTION CALCULATOR



[www.bossong.com/area-tecnica.html](http://www.bossong.com/area-tecnica.html)  
[www.bossong.co.uk/technical-area.html](http://www.bossong.co.uk/technical-area.html)  
[www.bossong.fr/section-technique.html](http://www.bossong.fr/section-technique.html)  
[www.bossong-befestigungssysteme.de/technische-abteilung.html](http://www.bossong-befestigungssysteme.de/technische-abteilung.html)